

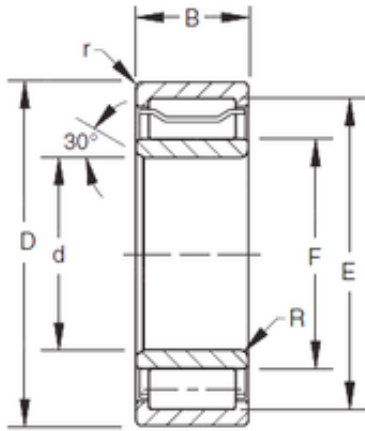

Horton Bearing Services

Bearing A-5248-WM

Bearing No. A-5248-WM



A-5248-WM Bearing 2D drawings and 3D CAD models

Bore Diameter	240 mm
Outer Diameter	402 mm
d	240 mm
F	285 mm
D	440 mm
E	402 mm
B	146,05 mm
C	146,05 mm
R	9,5 mm
r	3 mm